

1N5711, 1N5712, 5082-2800 Series

Schottky Barrier Diodes for General Purpose Applications



Data Sheet

Description/Applications

The 1N5711, 1N5712, 5082-2800/10/11 are passivated Schottky barrier diodes which use a patented "guard ring" design to achieve a high breakdown voltage. Packaged in a low cost glass package, they are well suited for high level detecting, mixing, switching, gating, log or A-D converting, video detecting, frequency discriminating, sampling, and wave shaping.

The 5082-2835 is a passivated Schottky diode in a low cost glass package. It is optimized for low turn-on voltage. The 5082-2835 is particularly well suited for the UHF mixing needs of the CATV marketplace.

Features

- Low Turn-On Voltage As Low as 0.34 V at 1 mA
- Pico Second Switching Speed
- High Breakdown Voltage Up to 70 V
- Matched Characteristics Available

Outline 15

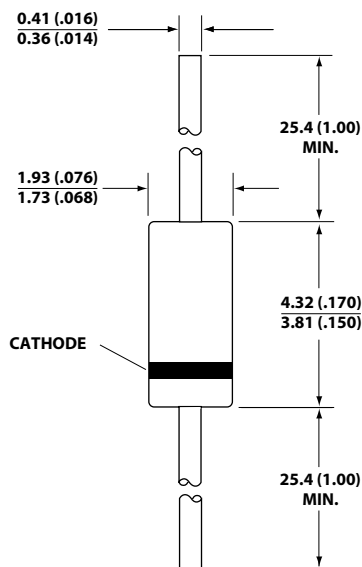

DIMENSIONS IN MILLIMETERS AND (INCHES).

Maximum Ratings

Junction Operating and Storage Temperature Range

1N5711, 1N5712, 5082-2800/10/11 -65°C to +200°C

5082-2835 -60°C to +150°C

DC Power Dissipation

(Measured in an infinite heat sink at $T_{CASE} = 25^{\circ}C$)

Derate linearly to zero at maximum rated temp.

1N5711, 1N5712, 5082-2800/10/11 250 mW

5082-2835 150 mW

Peak Inverse Voltage V_{BR}

Package Characteristics

Outline 15

Lead Material	Dumet
Lead Finish	95-5% Tin-Lead
Max. Soldering Temperature	260°C for 5 sec
Min. Lead Strength	4 pounds pull
Typical Package Inductance	
1N5711, 1N5712:.....	2.0 nH
2800 Series:.....	2.0 nH
Typical Package Capacitance	
1N5711, 1N5712:.....	0.2 pF
2800 Series:.....	0.2 pF

The leads on the Outline 15 package should be restricted so that the bend starts at least 1/16 inch from the glass body.

Outline 15 diodes are available on tape and reel. The tape and reel specification is patterned after RS-296-D.

Electrical Specifications at $T_A = 25^\circ\text{C}$

General Purpose Diodes

Part Number	Package Outline	Min. Breakdown Voltage	Max. Forward Voltage	$V_F = 1\text{ V Max. at Forward Current}$	Max. Reverse Leakage Current		Max. Capacitance
		$V_{BR} (V)$	$V_F (mV)$	$I_F (mA)$	$I_R (nA) \text{ at } V_R (V)$		$C_T (pF)$
5082-2800	15	70	410	15	200	50	2.0
1N5711	15	70	410	15	200	50	2.0
5082-2810	15	20	410	35	100	15	1.2
1N5712	15	20	550	35	150	16	1.2
5082-2811	15	15	410	20	100	8	1.2
5082-2835	15	8*	340	10*	100	1	1.0
Test Conditions		$I_R = 10 \mu A$ $*I_R = 100 \mu A$	$I_F = 1\text{ mA}$	$*V_F = 0.45\text{ V}$			$V_R = 0\text{ V}$ $f = 1.0\text{ MHz}$

Note: Effective Carrier Lifetime (τ) for all these diodes is 100 ps maximum measured with Krakauer method at 5 mA except for 5082-2835 which is measured at 20 mA.

Matched Pairs and Quads

Basic Part Number 5082-	Matched Pair Unconnected	Matched Quad Unconnected	Batch Matched ^[1]	Test Conditions
2800	5082-2804 $\Delta V_F = 20 \text{ mV}$	5082-2805 $\Delta V_F = 20 \text{ mV}$		ΔV_F at $I_F = 0.5, 5 \text{ mA}$ * $I_F = 10 \text{ mA}$ ΔC_O at $f = 1.0 \text{ MHz}$
2811			5082-2826 $\Delta V_F = 10 \text{ mV}$ $\Delta C_O = 0.1 \text{ pF}$	ΔV_F at $I_F = 10 \text{ mA}$ ΔC_O at $f = 1.0 \text{ MHz}$
2835			5082-2080 $\Delta V_F = 10 \text{ mV}$ $\Delta C_O = 0.1 \text{ pF}$	ΔV_F at $I_F = 10 \text{ mA}$ ΔC_O at $f = 1.0 \text{ MHz}$

Note:

1. Batch matched devices have a minimum batch size of 50 devices.

SPICE Parameters

Parameter	Units	5082-2800	5082-2810	5082-2811	5082-2835
B_V	V	75	25	18	9
C_{J0}	pF	1.6	0.8	1.0	0.7
E_G	eV	0.69	0.69	0.69	0.69
I_{BV}	A	$10E-5$	$10E-5$	$10E-5$	$10E-5$
I_S	A	$2.2 \times 10E^{-9}$	$1.1 \times 10E^{-9}$	$0.3 \times 10E^{-8}$	$2.2 \times 10E^{-8}$
N		1.08	1.08	1.08	1.08
R_S	Ω	25	10	10	5
P_B	V	0.6	0.6	0.6	0.56
P_T		2	2	2	2
M		0.5	0.5	0.5	0.5

Typical Parameters

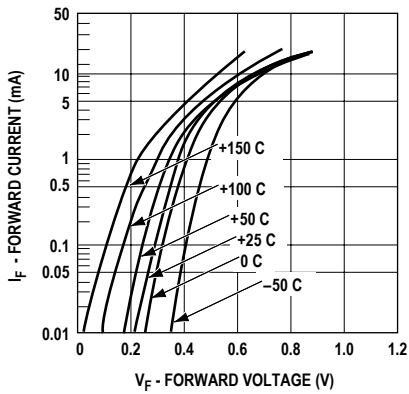

Figure 1. I-V Curve Showing Typical Temperature Variation for 5082-2800 or 1N5711 Schottky Diodes.

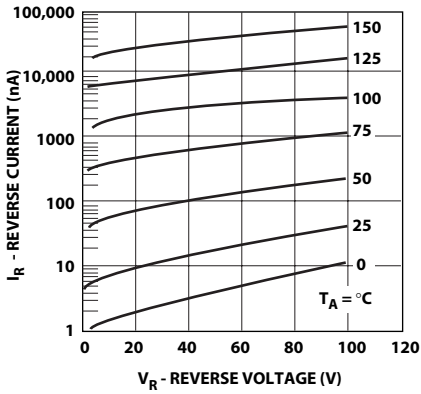

Figure 2. (5082-2800 OR 1N5711) Typical Variation of Reverse Current (I_R) vs. Reverse Voltage (V_R) at Various Temperatures.

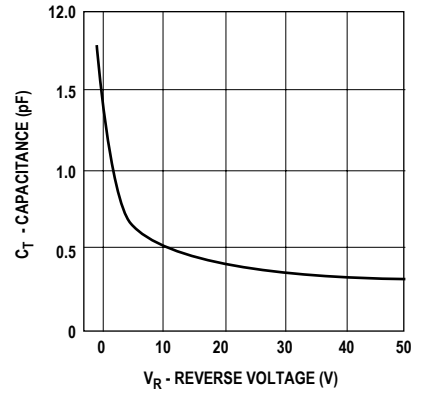

Figure 3. (5082-2800 or 1N5711) Typical Capacitance (C_T) vs. Reverse Voltage (V_R).

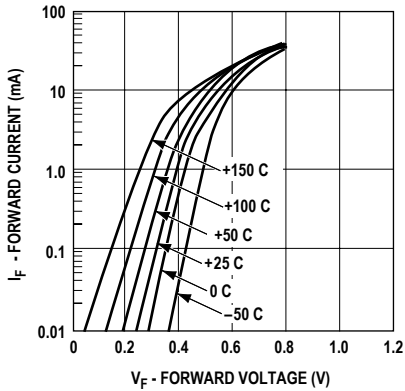

Figure 4. I-V Curve Showing Typical Temperature Variation for the 5082-2810 or 1N5712 Schottky Diode.

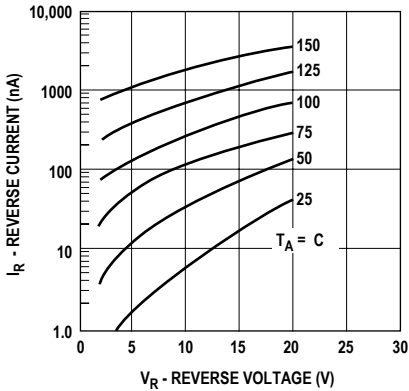

Figure 5. (5082-2810 or 1N5712) Typical Variation of Reverse Current (I_R) vs. Reverse Voltage (V_R) at Various Temperatures.

Notes:

Typical values were derived using limited samples during initial product characterization and may not be representative of the overall distribution

Typical Parameters, *continued*

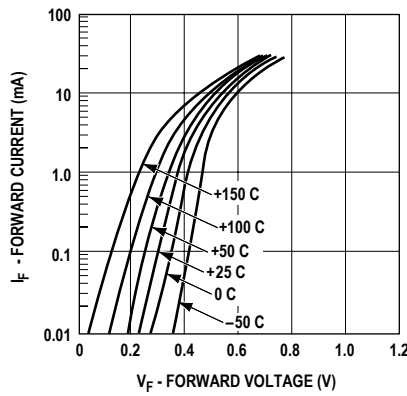

Figure 6. I-V Curve Showing Typical Temperature Variation for the 5082-2811 Schottky Diode.

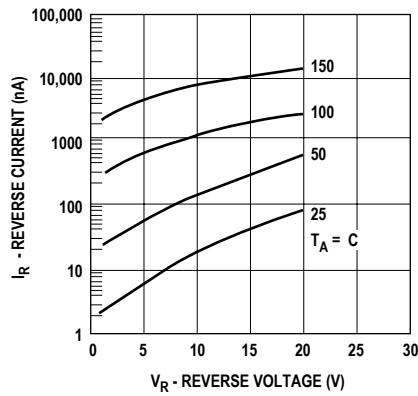

Figure 7. (5082-2811) Typical Variation of Reverse Current (I_R) vs. Reverse Voltage (V_R) at Various Temperatures.

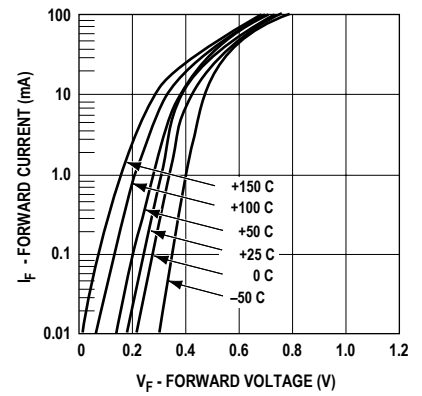

Figure 8. I-V Curve Showing Typical Temperature Variations for 5082-2835 Schottky Diode.

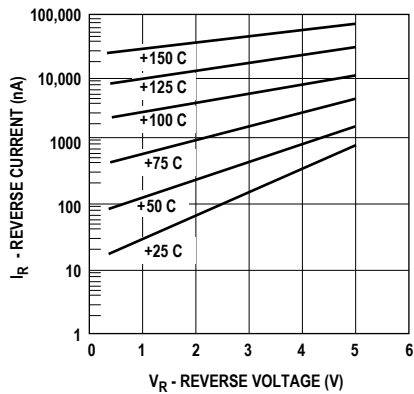

Figure 9. (5082-2835) Typical Variation of Reverse Current (I_R) vs. Reverse Voltage (V_R) at Various Temperatures.

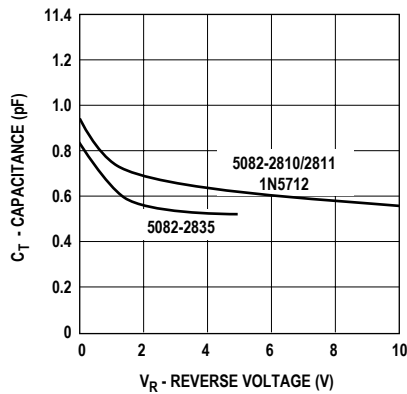

Figure 10. Typical Capacitance (C_T) vs. Reverse Voltage (V_R).

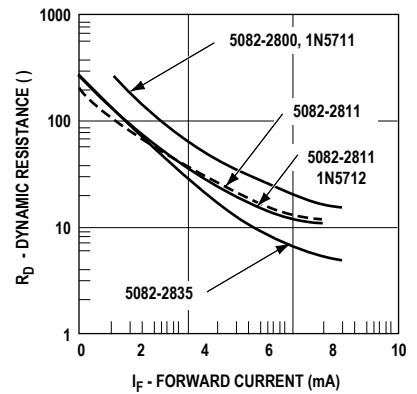

Figure 11. Typical Dynamic Resistance (R_D) vs. Forward Current (I_F).

Notes:

Typical values were derived using limited samples during initial product characterization and may not be representative of the overall distribution

Tape Dimensions and Product Orientation

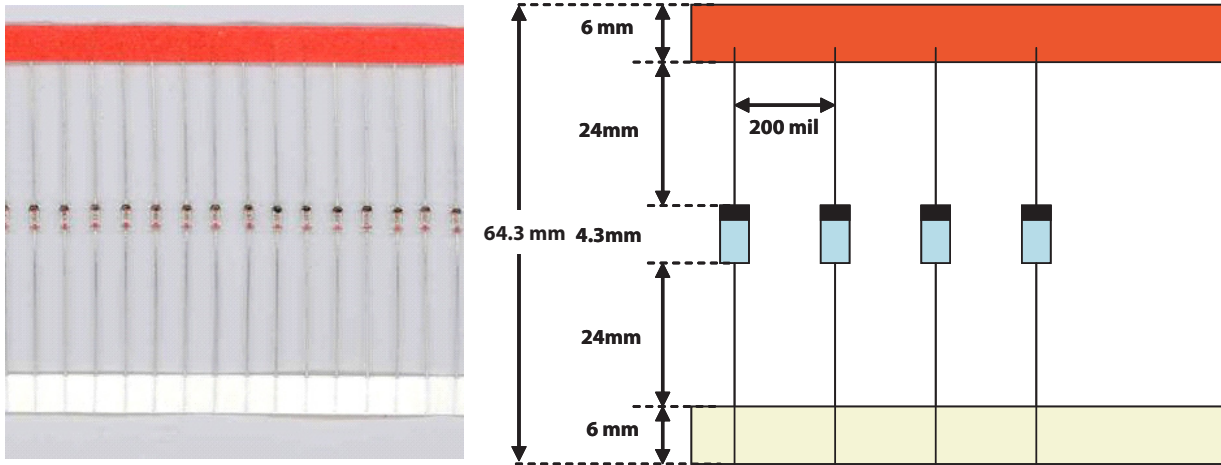

Figure 13.

RFD Reel Dimensions for T25/T50

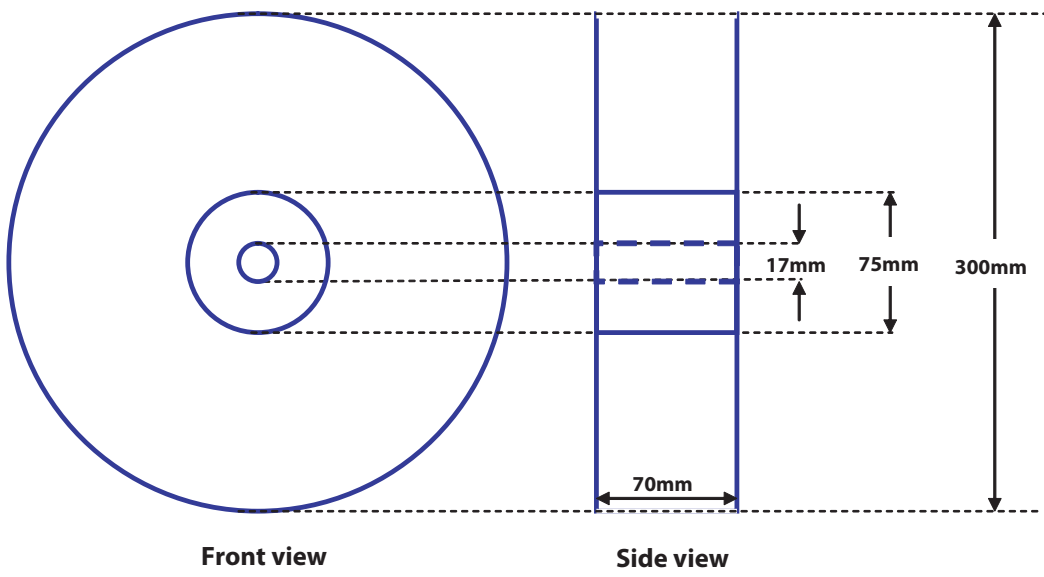

Figure 14.

Diode Package Marking

1N5xxx 5082-xxxx

would be marked:

1Nx xx

xxx xx

YWW YWW

where xxxx are the last four digits of the 1Nxxxx or the 5082-xxxx part number.

Y is the last digit of the calendar year. WW is the work week of manufacture.

Examples of diodes manufactured during workweek 45 of 1999:

1N5712 5082-3080

would be marked:

1N5 30

712 80

945 945

Part Number Ordering Information

Part Number	No. of devices	Container
5082-28xx#T25/1N57xx#T25	2500	Tape & Reel
5082-28xx#T50/ 1N57xx#T50	5000	Tape & Reel
5082-28xx/ 1N57xx	100	Antistatic bag

For product information and a complete list of distributors, please go to our web site: www.avagotech.com

Avago, Avago Technologies, and the A logo are trademarks of Avago Technologies, Limited in the United States and other countries. Data subject to change. Copyright © 2006 Avago Technologies, Limited. All rights reserved. Obsoletes 5989-3680EN AV02-0429EN - June 6, 2007

